

# Data Sheet



Article number: 2307083131

Description: E+G Direct drive position indikator  
DD52R-FN-001.00-D-C3 (Grey)

## Measures

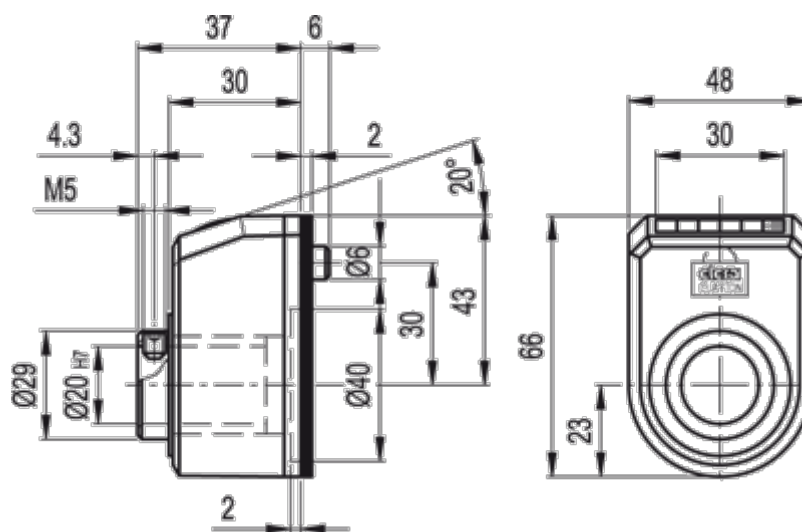

Max rpm = 250